



Technology for Life Science

Quantitative measurement equipment
for flare in the anterior chamber

Laser Flare Meter

Kowa FM-600

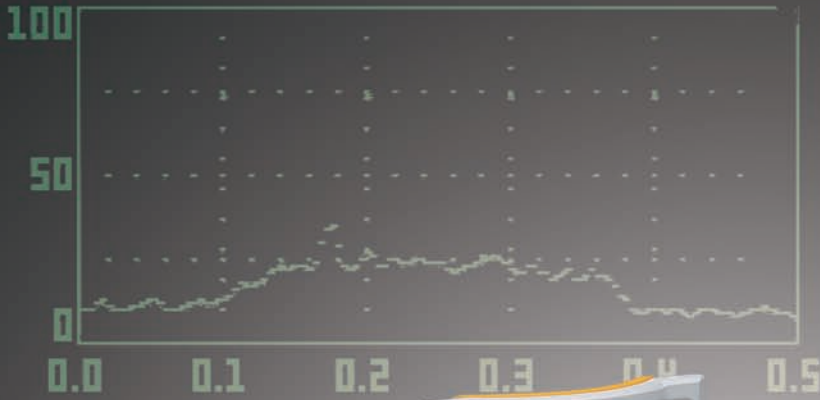

BG1: 9.7
 BG2: 8.1 (8.8%)
 SIG: 21.8

FLARE: 12.9



N	FLARE	FLARE	W/A
1	3.5	13.5	
2	6.4	11.9	
3	7.0	13.8	C
4	6.0	13.9	
5	5.4	12.5	B
6	6.7	10.8	
AV. :		12.7	
S.D. :		1.2	

User-friendly, patient-friendly, designed to be the best partner.

Non-contact, non-invasive, non-pain, in-vivo, all is possible with this one-compact Kowa FM-600 especially elaborated for quantitative measurement of aqueous flare. This measurement is known as being useful in follow-up observation of flare for patients with uveitis, after IOL implantation. Designed to operate faster, to conduct easier and better, Kowa FM-600 reflects what is efficient and accurate compactness.

Alignments



Working distance adjustment

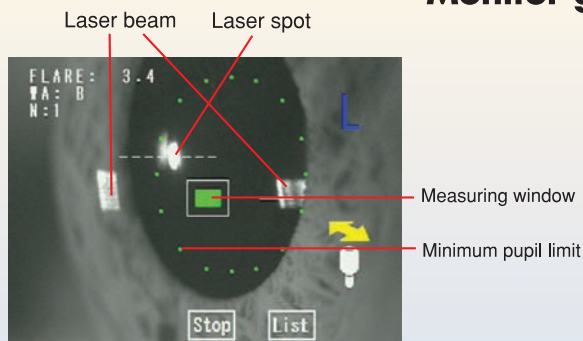

Measuring point adjustment

Position the luminous alignment dot in the center circle while bringing the dot into focus. Then shift to the oblique alignment by pressing the joystick button. Measurement is possible when the measuring window at the center is green.

Monitor guide for easy

Measuring view

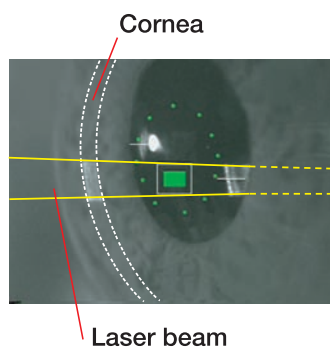

Measuring window

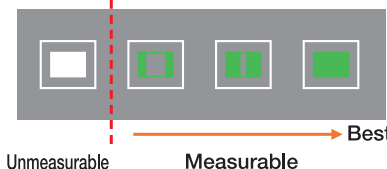

The color and form of the measuring window depends on the alignment. Measurement cannot be made when the central square is white; measurement is possible when this same square is green.

Electrically operated chin rest



Vertical movements of the chin rest are electrically operated, for smooth adjustments of the patient's eye.



Usable in bright rooms

Measurements can be made in bright rooms with the use of this Light Shade.



Compact

Simple & Speedy

Easy Alignments

All the Kowa's miniaturization technologies were put together to compile all necessary functions a Flare Meter needs in a compact body.

With operations made while facing the patient and all buttons located at hand reach, the Flare Meter has become much easier to use than ever.

Quick and accurate measurements with facilitated alignments on the measurement area displayed on the monitor.

and quick alignment



Measurement results

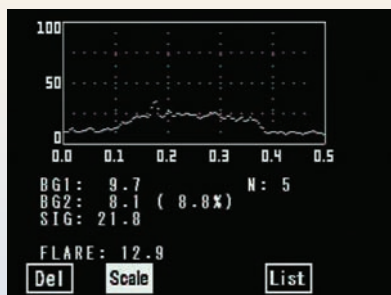

Graph results

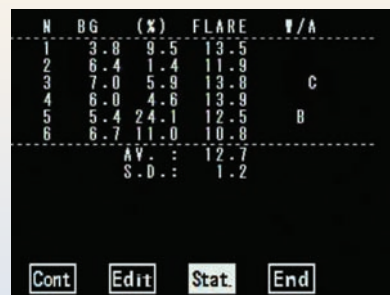

Report results

The scattered light is converted into electrical signal and its intensity is displayed as flare value on the LCD monitor.

Printout



N	BG	(%)	FLARE	W/A
1	47.9	15.5	17.7	B
2	6.4	7.4	13.1	
3	6.2	1.7	16.1	
4	7.2	8.9	16.3	C
5	6.6	0.8	14.9	
6	7.2	6.6	14.8	
7	7.3	20.6	15.6	B
8	6.8	9.2	16.2	

AV.: 15.6
S.D.: 1.4

Built-in thermal printer and easy paper change to support quick operations.

Calibration

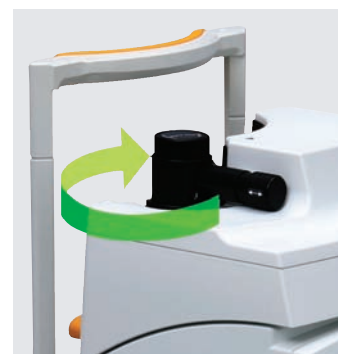

Pre-installed calibrator on the body for easy calibration.

Measurement Principle

Kowa FM-600 is based on the measurement principle of laser light scattering detection. The instrument uses a diode laser beam to scan a measuring window that is projected inside the anterior chamber of the eye.

As an aqueous protein (component of inflammation) passes through the focal point of the laser, light scattering occurs.

The intensity of the scattered light (directly proportional to the amount of protein particles-flare) is detected by a photo-multiplier tube (PMT), which generates an electrical signal.

These signals are immediately digitized to eliminate outside noise interference and are processed by a computer that displays for user analysis.

The unit of measurement employed by the FM-600 is photon counts per millisecond.

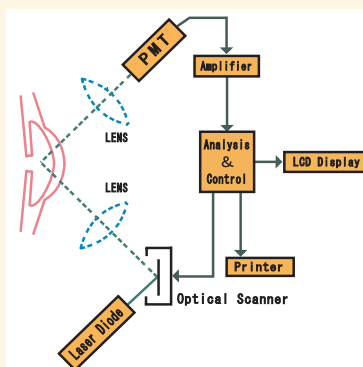



Specifications

Measuring laser source	Laser Diode: 635nm 35±15 μw
Detector	Photo-multiplier tube (PMT)
Measuring range	1~500 photon count/ms
Measuring field	Vertical 0.3mm×horizontal 0.5mm
Measuring time	0.5 second
Working distance	81mm (distance of examined eye to front end of objective lens)
Printer	58mm width, thermal line printer
Monitor	5.6 inch color LCD monitor
Movement range	Movable 37mm backward / forward Movable 89mm leftward / rightward Movable 25mm vertically (electric)
Interface	ID input: PS/2※ (compatible with numerical keypad, barcode reader) Data output: RS-232C
Power supply	Input: AC100~230V 50/60Hz Power consumption: 80VA (normal) / 100VA (maximum)
Dimensions / weight	274(W)×457(D)×458(H)mm / 18kg

Accessory



Light Shade

CE 0197

※Product names and company names stated in this brochure are all trademarks or registered trademarks of each company.
Images of the monitor are compositions.
Specifications and appearances are subject to change without notice.

Distribution name : KOWA FM-600
* 510k pending.

Kowa *Kowa Company, Ltd.*

World Sales Headquarters

4-14, Nihonbashi-honcho 3-chome, Chuo-ku, Tokyo 103-8433 Japan
Phone: 81(3)5623-8059 Facsimile: 81(3)5623-8060
URL: <http://www.kowa.co.jp/e-life/>

Hamamatsu Factory

3-1, Shinmiyakoda 1-chome, Kita-ku, Hamamatsu City, Shizuoka Pref., 431-2103 Japan

Kowa Europe GmbH *Kowa Optimed, Inc.*
Immermannstrasse 43B 20001 S. Vermont Ave.
40210 Duesseldorf, F.R. Germany Torrance, CA 90502, U.S.A.
Phone: 49(211)1793540 Phone: 1(310)327-1913
Facsimile: 49(211)161952 Facsimile: 1(310)327-4177
URL: <http://kowa-europe.com/> URL: <http://medical.kowa.com/>



This catalog was made with recycled paper.
Printed in Japan. LSS50_0890300JM/K-1